

# WORKSHEET 3 PERIMETER DAN LUAS SEKTOR

[1]

Kira perimeter dan luas kawasan berlorek bagi setiap yang berikut:

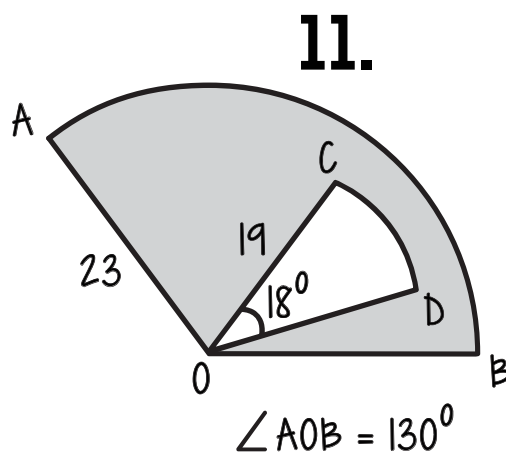
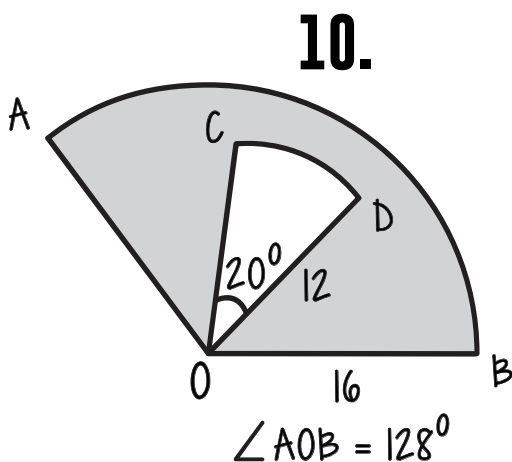
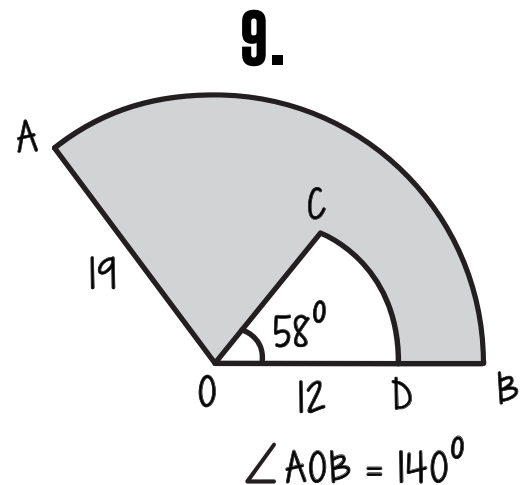
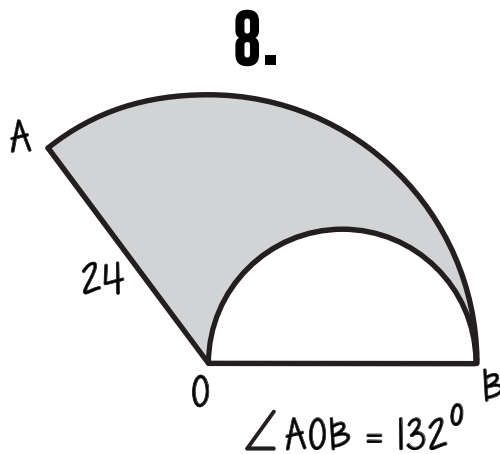
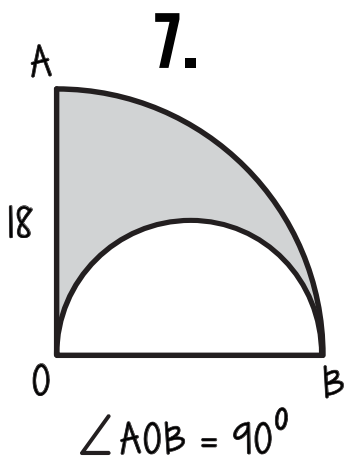
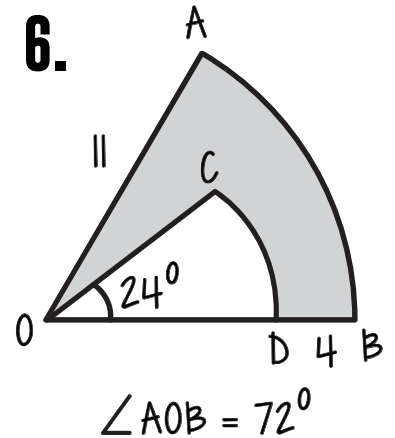
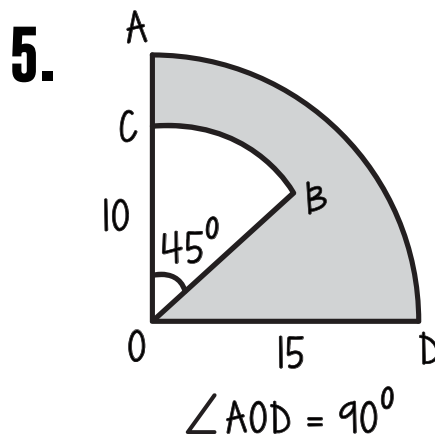
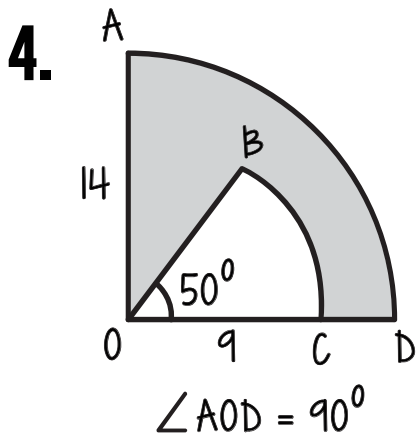
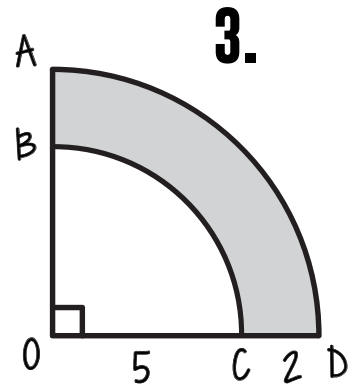
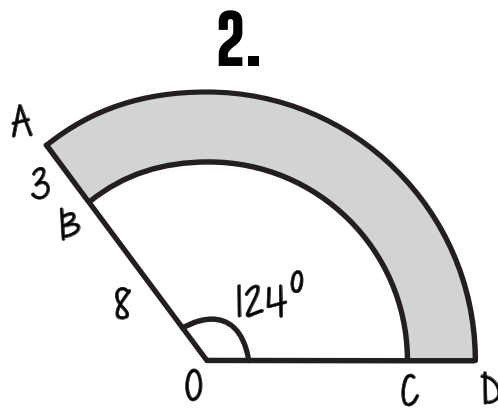
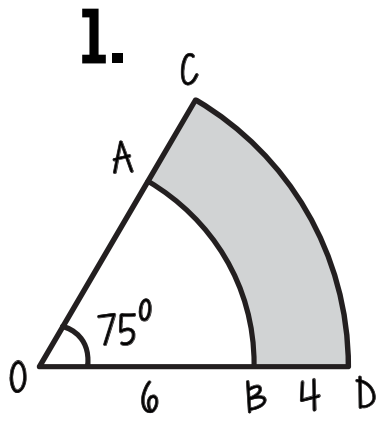

# WORKSHEET 3 PERIMETER DAN LUAS SEKTOR

[ 2 ]

Kira perimeter dan luas kawasan berlorek bagi setiap yang berikut:

**12.**

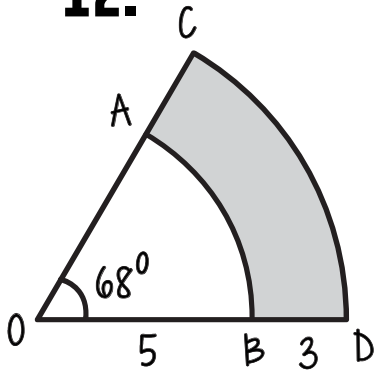

**13.**

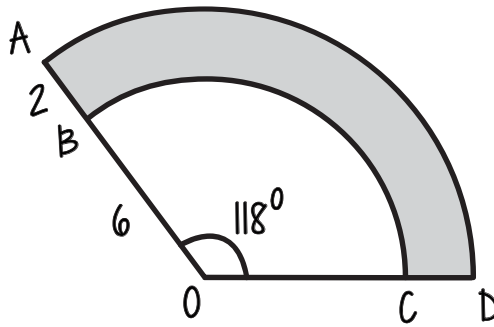

**14.**

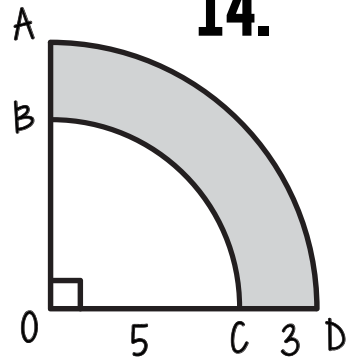

**15.**

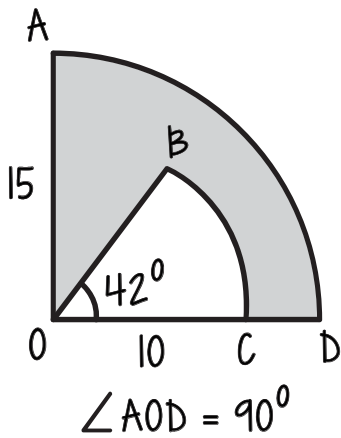

**16.**

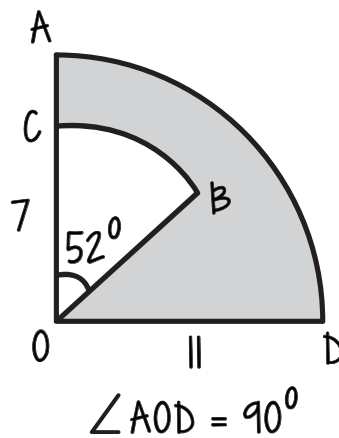

**17.**

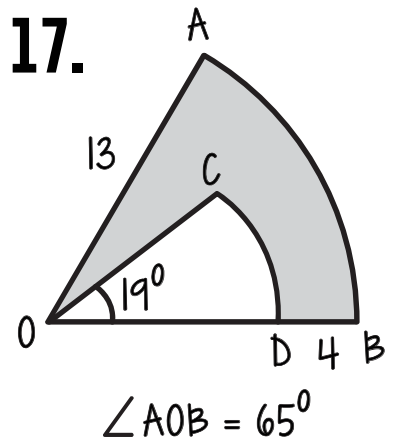

**18.**

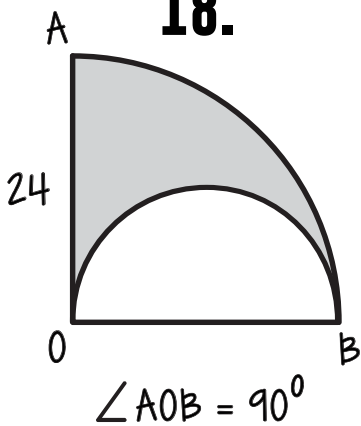

**19.**

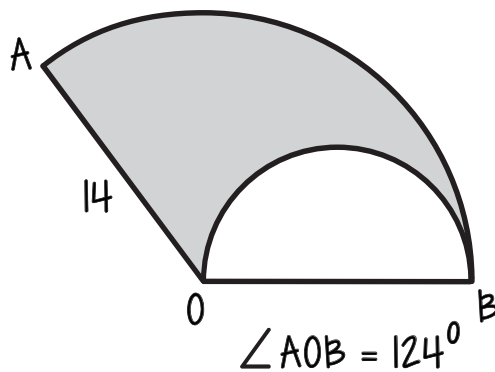

**20.**

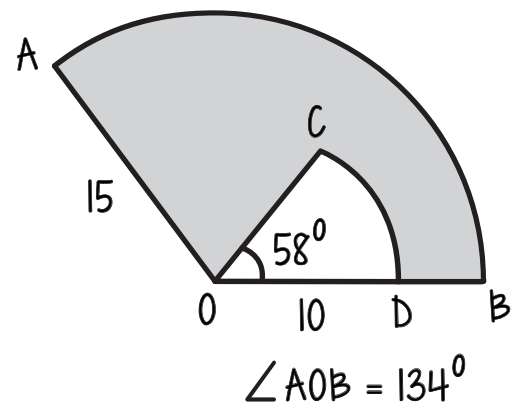

**21.**

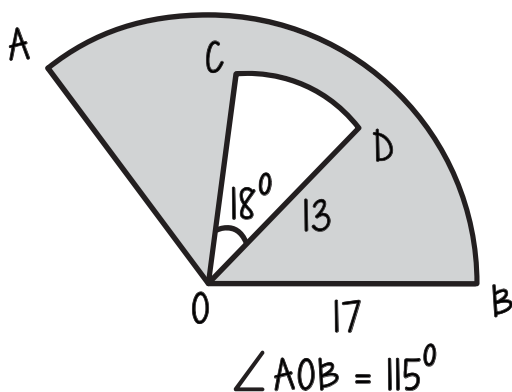

**22.**

